

Dulap KSC 2

INDEX	REPER	GROSIME	LUNGIME	LATIME	NB.	INDEX	REPER	NB.
1	PAL C1 - Perete lateral stanga	16	1952	352	1	8	Capac mascare ericson	26
2	PAL C1 - Perete lateral dreapta	16	1952	352	1	9	Cep lemn 8x35mm	8
3	PAL C1 - Polita	16	804	352	1	10	Picior tip "Tinta"	4
4	PAL C1 - Intermediar	16	359	352	5	11	Surub confirmator (Ericson 7x50)	38
5	PAL C1 - Lezena	16	804	60	1	12	Tinte	95
6	PAL C2 - Polita	16	804	352	5			
7	PFL spate corp	3	832	375	5			

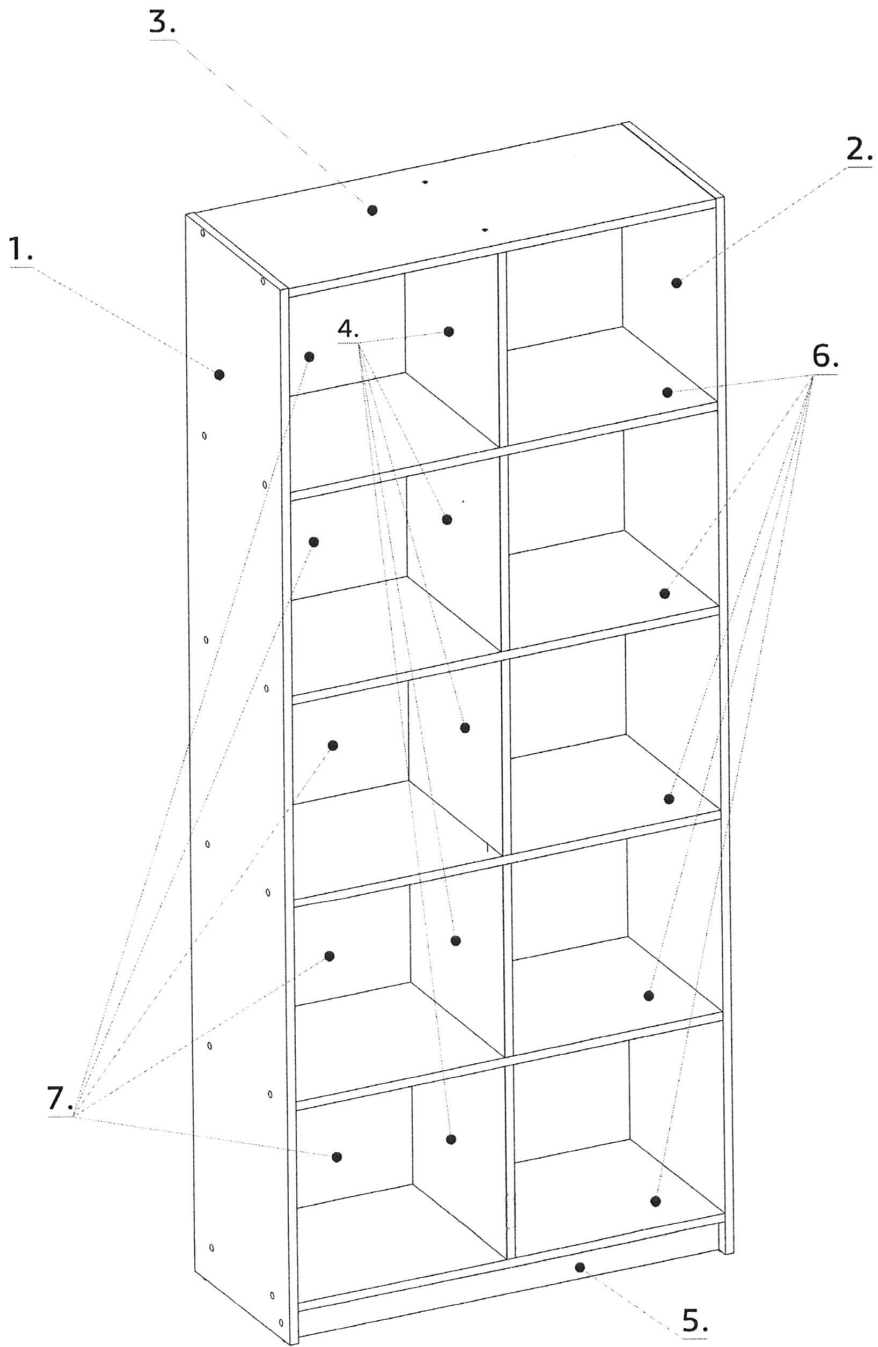

MATERIAL	BUC.
Capac mascare ericson	26
Cep lemn 8x35mm	8
Picior tip "Tinta"	4
Surub confirmator (Ericson 7x50)	38
Tinte	95

abs 0,4 x 22 - 14 ml

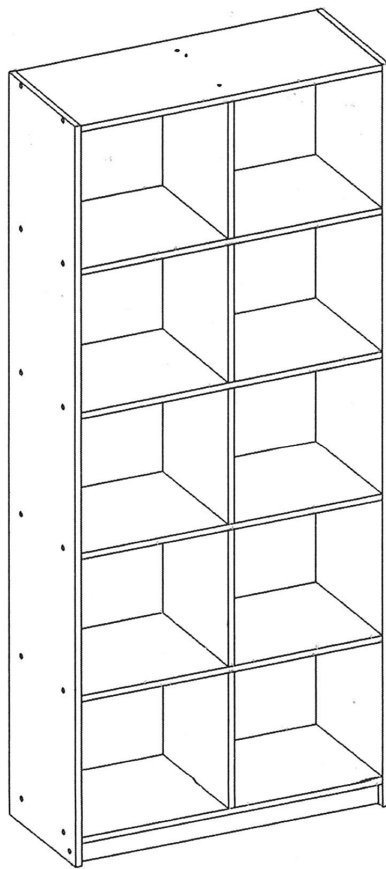

Dulap KSC 2

MATERIAL	GROSIME	LUNGIME	CANT_LU	LATIME	CANT_LA	BUC.
PAL C1 - Intermediar	16	359	1	352	-	5
PAL C1 - Lezena	16	804	1	60	-	1
PAL C1 - Perete lateral dreapta	16	1952	1	352	2	1
PAL C1 - Perete lateral stanga	16	1952	1	352	2	1
PAL C1 - Polita	16	804	1	352	-	1
PAL C2 - Polita	16	804	1	352	-	5
PFL spate corp	3	832	-	377	-	5

abs 0,4x22-14 ml

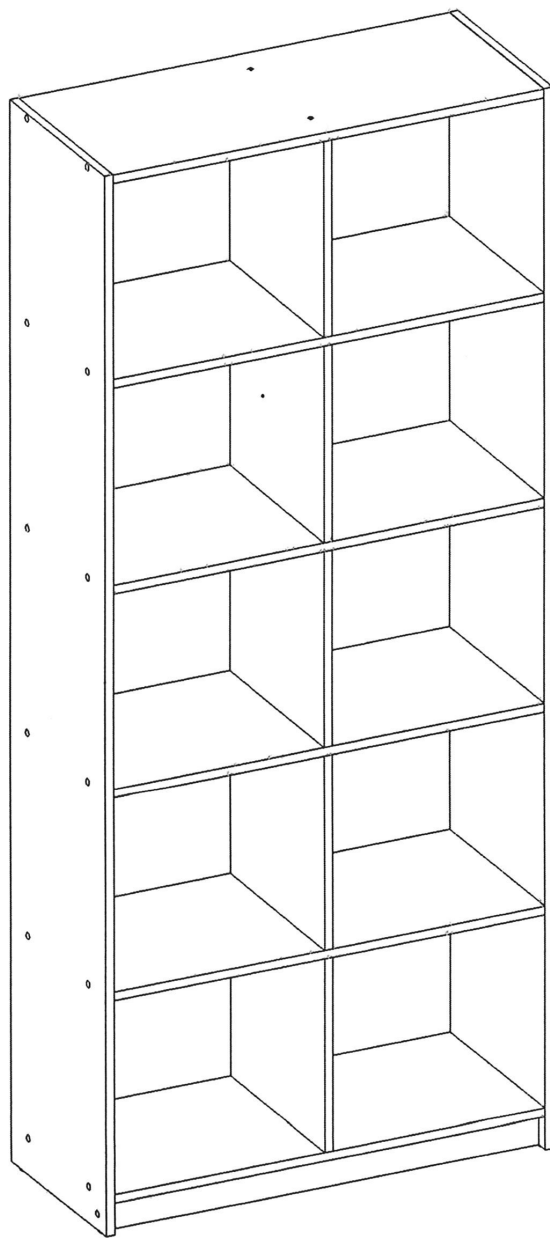

Dulap T2

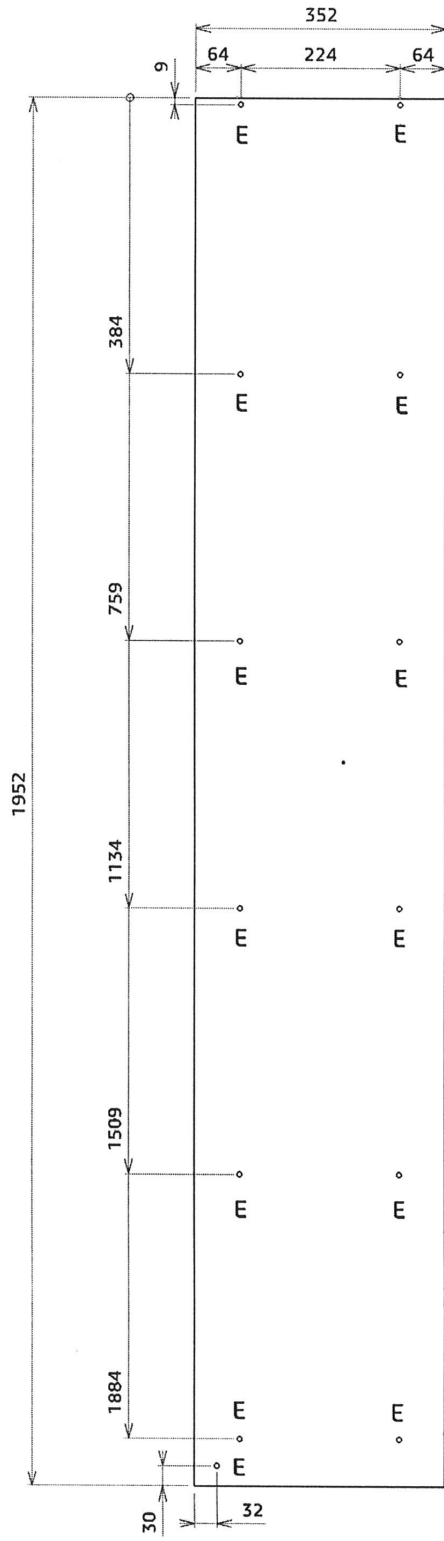

Perete lateral :
1952 x 352 - 2buc (st/dr)

Dulap T2

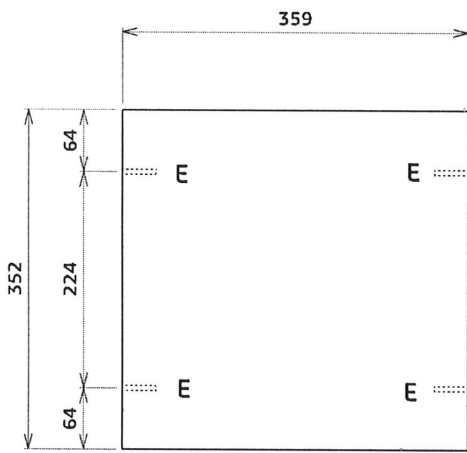
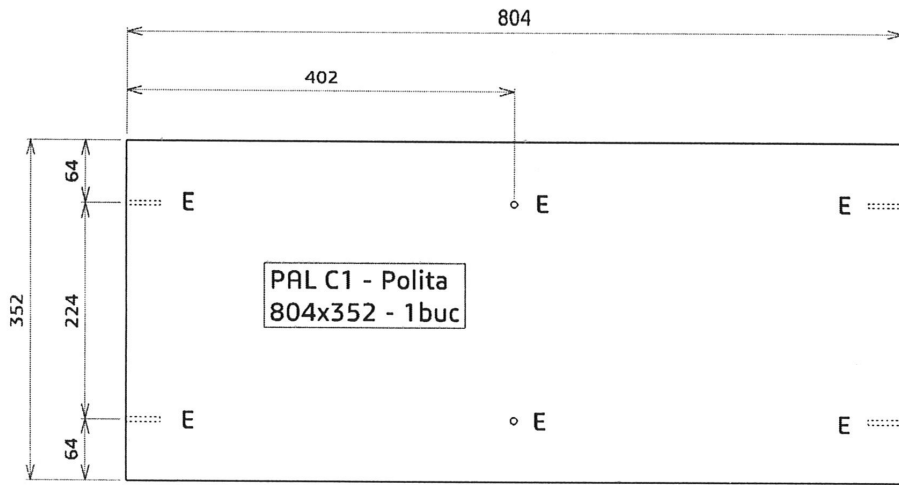

**PAL C1 - Intermediar 1
359x352 - 3buc**

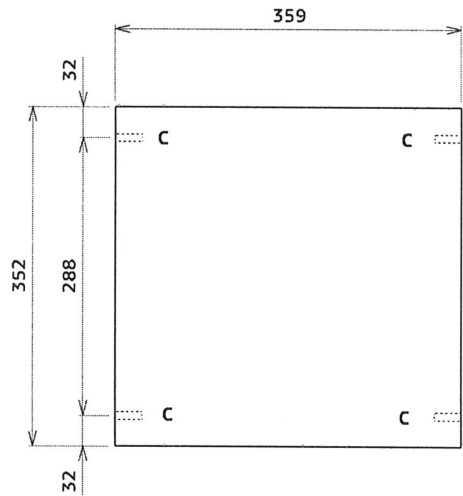

**PAL C1 - Intermediar 2
359x352 - 2buc**

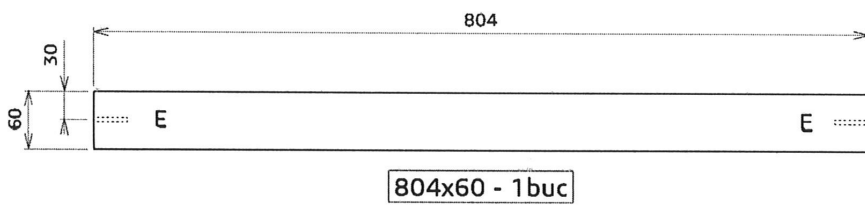

Dulap KSC 2

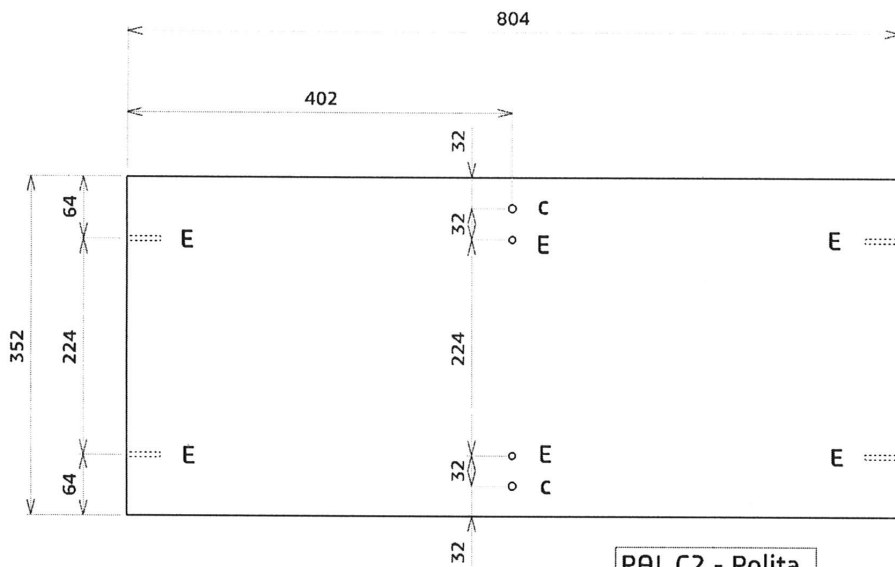

PAL C2 - Polita
804x352 - 4buc

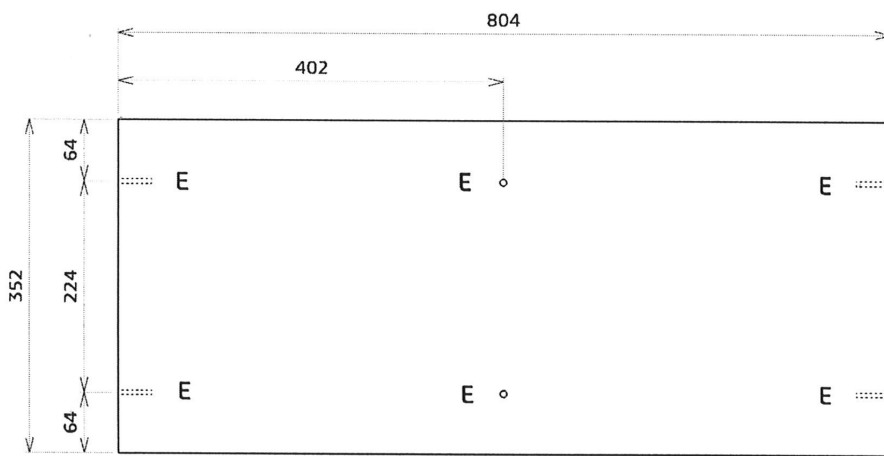

PAL C2 - Polita
804x352 - 1buc