

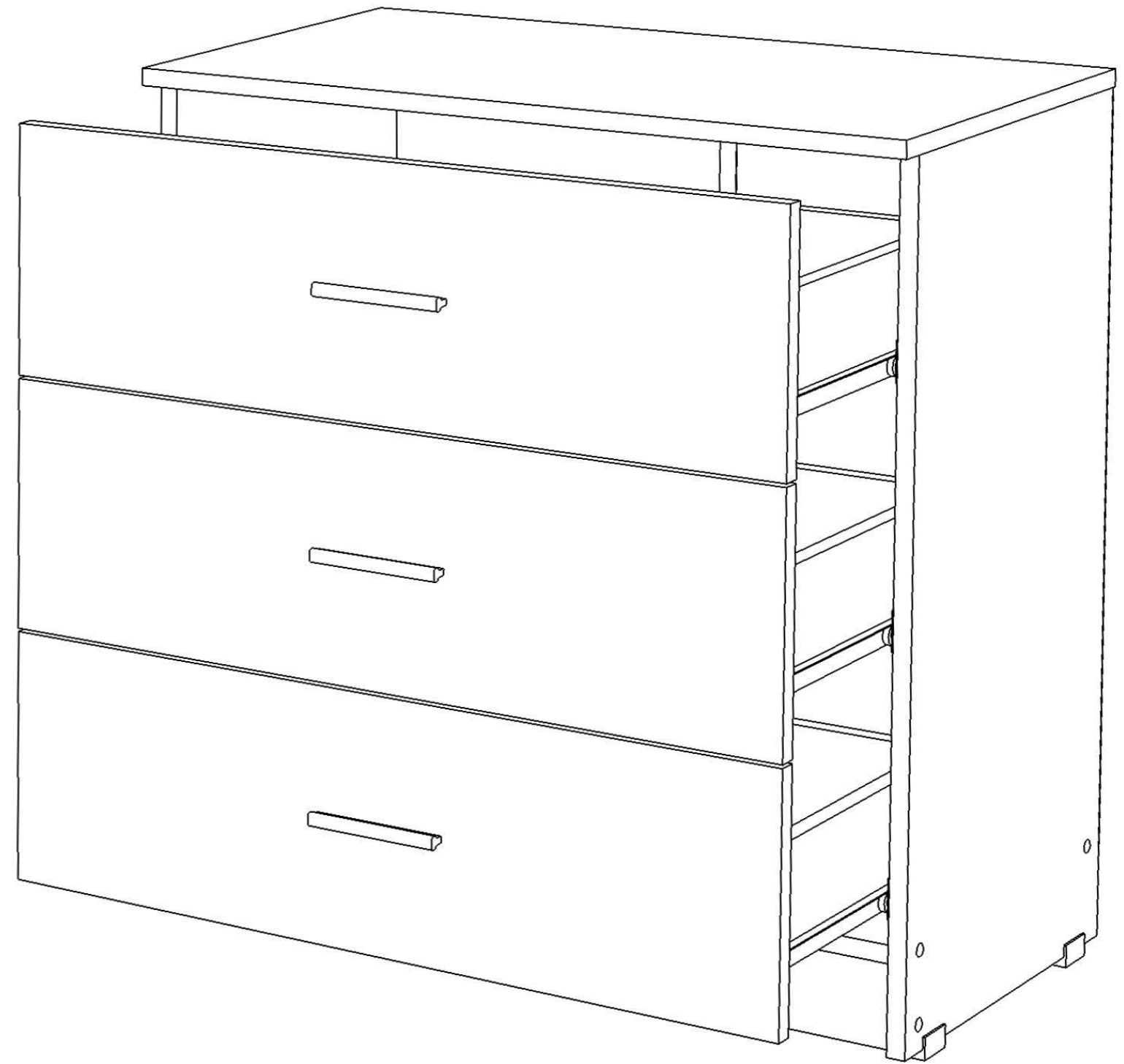

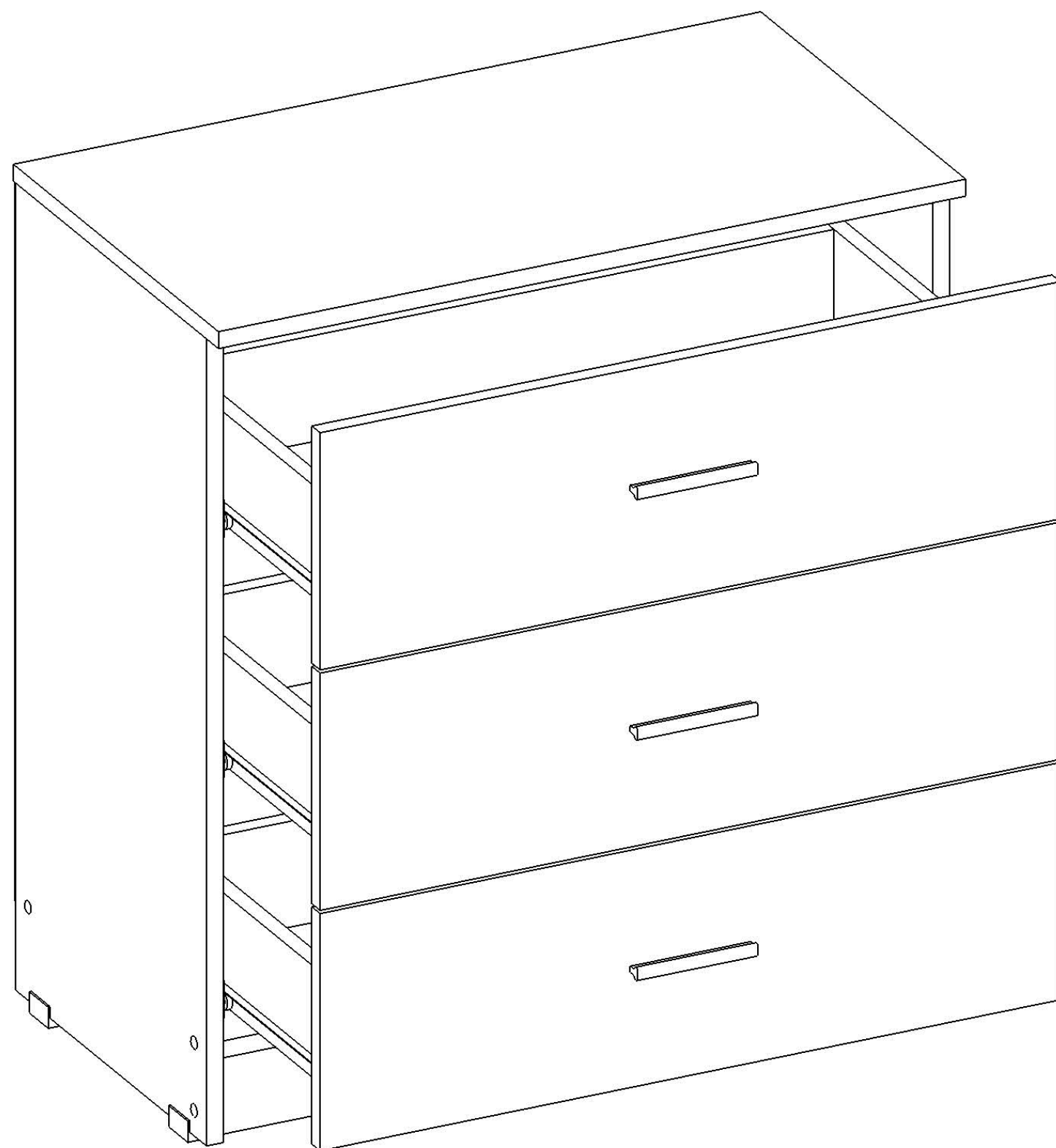





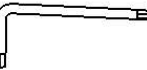

COMODA 3B

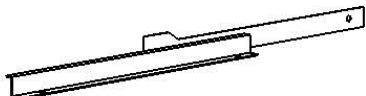

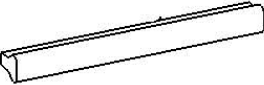
COMODA 3 B : ACCESORII



DENUMIRE	POZA	Nr. Buc.
Aracet (Gr.)		50
Capac Mascare Ericson		18
Cep Lemn 8x35		14
Cheie Imbus		1
Ericson 7x50		20
Glisiera 350 (Set-uri)		3
Holzsurub 3.5x16		12
Holzsurub 3.5x25		26
Maner 96mm		3
Picior H10mm (Alunecator)		4
Profil Imbinare PFL (L=696mm)		1
Surub Maner M 4x35		6
Tinte		100

COMODA 3 B - SCHITA MONTAJ

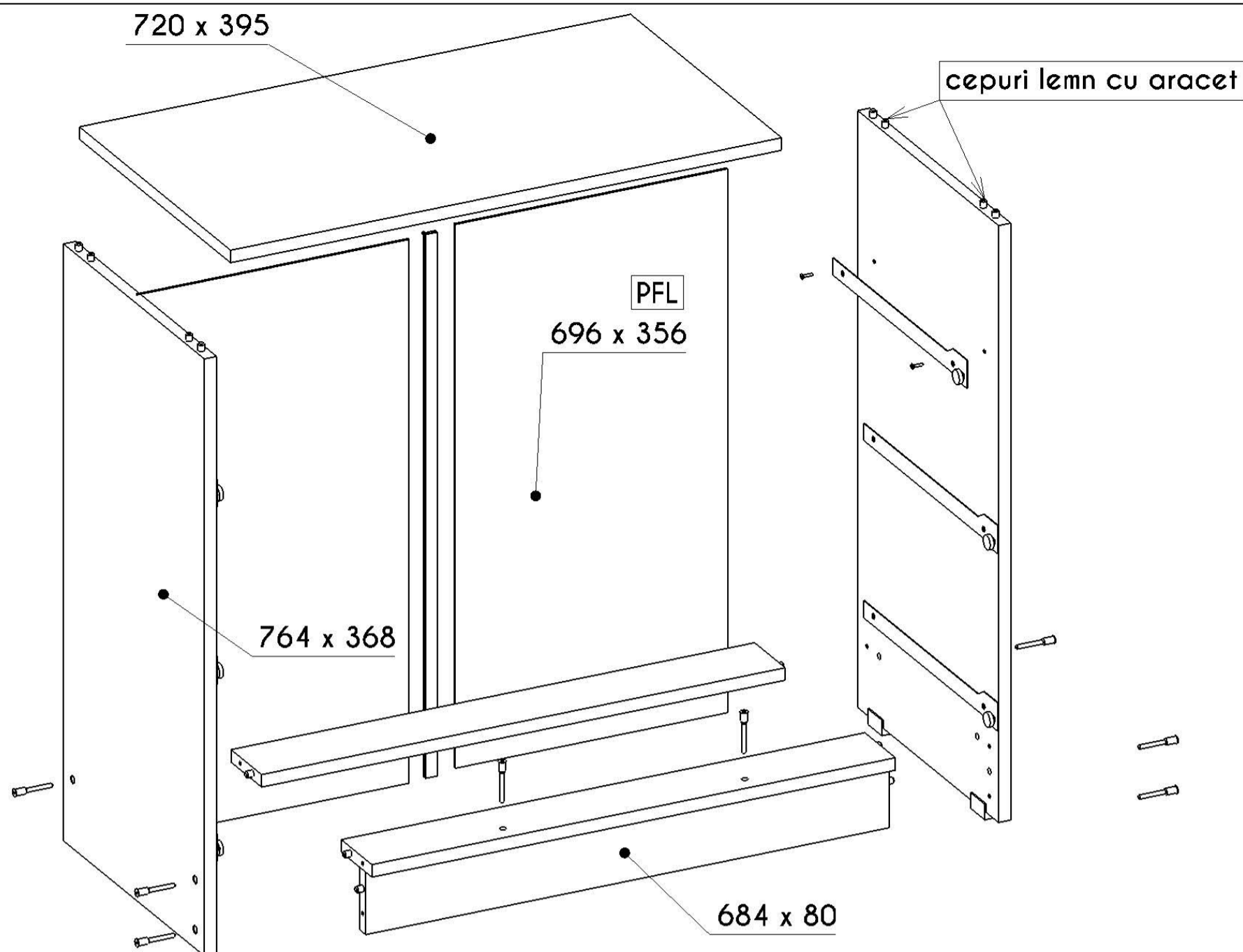

DENUMIRE	POZA	Nr. Buc.
Aracet		50 gr
Capac Mascare Ericson		18
Cep Lemn 8x35		14
Cheie Imbus		1
Ericson 7x50		20
Glisiera		3 set-uri
Holzsurub 3.5x16		12
Holzsurub 3.5x25		26
Maner		3
Picior (Alunecator)		4
Profil Imbinare PFL		1
Surub M 4x35		6
Tinte		100

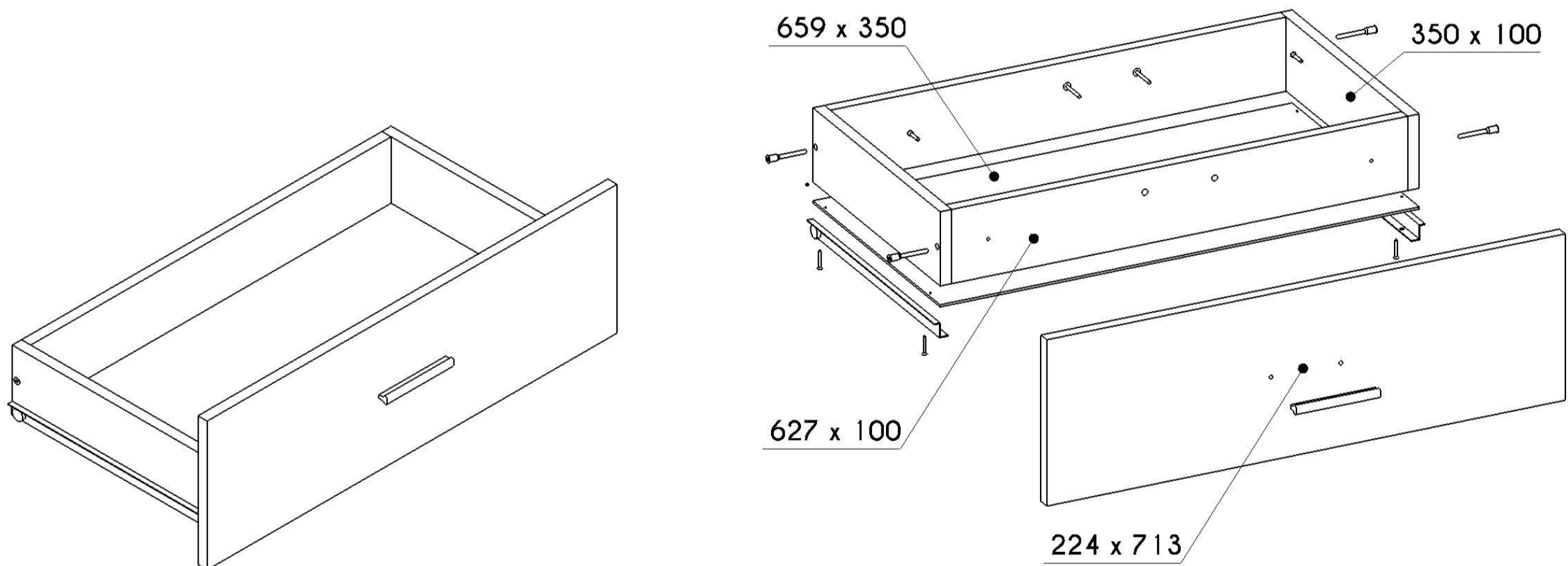

DETALII MONTAJ

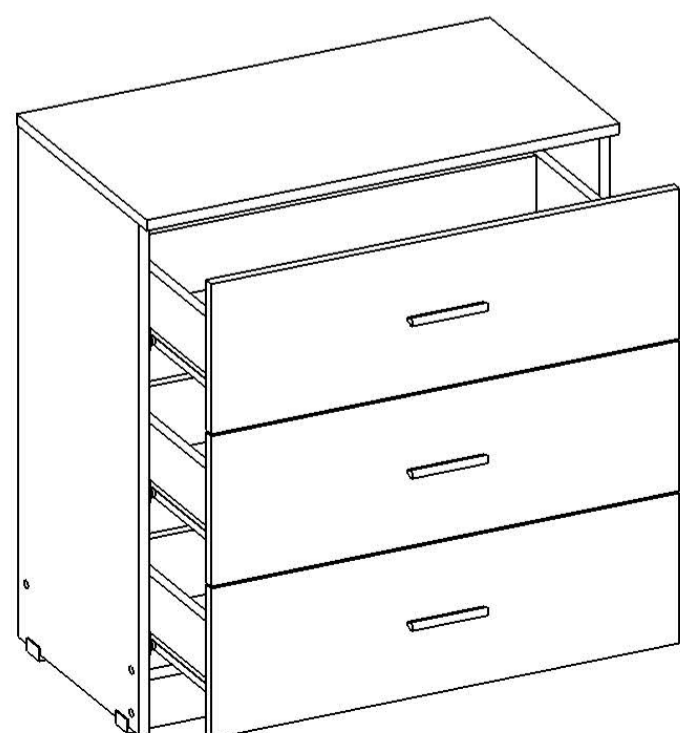

- se pune aracet in partea de sus a peretilor laterali (764x368) si se bat cepurile cu atentie
 - se bat cep-urile din lemn in lezene (684x80)
 - se prind glisierile de peretii laterali cu holzs. 3.5x16 cu rola spre partea cantuita
 - se prind picioarele (in cantul peretilor laterali) la 40mm fata de margine. (se folosesc holzsuruburi 3.5x25)
 - se aseaza peretele lateral stanga cu partea cantuita in jos si se prind cele 3 lezene (cu ericsoane si cheie imbus)
 - se prinde peretele lateral dreapta
 - se ridica corpul pe picioare, se pune aracet in gaurile din capac si se va fixa in peretii laterali (va fi aliniat la spate)
 - se lasa 5 min. pana se intareste aracetul
 - se aseaza comoda cu partea cantuita in jos, se impinge in colturi pana cand cele 2 diagonale sunt egale
 - se bate PFL-ul in tinte (dist. intre tinte este de 100mm)
 - se vor monta cele 2 sertare
 - se prinde cutia cu ericsoane, se verifica cele 2 diagonale sa fie egale, se bate PFL-ul in tinte. Se aseaza cele 2 glisiere pe cutie (lipite de cutie) si se prind cu holzsuruburi 3.5x25, cu rola spre spate.
- ATENTIE .** Fiecare cutie de sertar, este formata din cate 1 placa 627x100 cu gauri pt. maner si una fara. (cea fara gauri este in spate).
- se prinde fata de sertar cu suruburi maner 4x35, se pun sertarele pe glisierile din comoda, se regleaza lufatul intre sertare (3mm), se scot afara, pe rand si se vor fixa cu cate 2 holzsuruburi 3.5x25.